



Venus Single Board Computer

3.5" Form Factor SBC

with Intel "Skylake" Core i7 6th Generation Processor



Revision	Date	Comment
1.00	03/13/2017	Initial Release
1.1a	06/20/2017	Power Supply and Thermal Solutions section updated.
1.1b	08/24/2017	Updated JP2 jumper section
1.1c	08/31/2017	Updated Digital IO spec and connector mating parts

**FOR TECHNICAL SUPPORT
PLEASE CONTACT:**

support@diamondsystems.com

Copyright 2016
Diamond Systems Corporation
555 Ellis Street
Mountain View, CA 94043 USA
Tel 1-650-810-2500
Fax 1-650-810-2525
www.diamondsystems.com

CONTENTS

1	Important Safe Handling Information	4
2	Introduction	6
2.1	Standard Configurations	6
2.2	Features.....	6
2.3	Operating System Support	7
2.4	Mechanical, Electrical, Environmental.....	7
3	Functional Block Diagram	8
3.1	Feature Descriptions	9
3.1.1	Processor and Chipset.....	9
3.1.2	Memory	9
3.1.3	Ethernet.....	9
3.1.4	SATA.....	9
3.1.5	USB.....	9
3.1.6	Video	10
3.1.7	Audio	10
3.1.8	Serial Ports	10
3.1.9	Digital IO	10
3.1.10	Backup Battery.....	10
3.1.11	TPM.....	10
3.1.12	PCIe Minicard Socket	11
3.1.13	PCI-104 and One Bank PCIe/104 Expansion.....	11
3.1.14	PCIe link routing.....	11
3.1.15	LED Indicators	11
3.1.16	BIOS Features	12
3.1.18	Power Supply	13
4	Mechanical Board Drawing.....	14
5	Board Layout (Connector and Jumper Locations).....	15
6	I/O Connectors	17
6.1	Connector Pin-out and Signal Description	17
6.2	Connector Pin-out and Signal Description	17
6.2.1	Power In (J12).....	17
6.2.2	External Battery (J14)	17
6.2.3	USB 2.0 Ports (J4)	17
6.2.4	USB 3.0 Port (J18, J19)	18
6.2.5	Serial Ports (J6,J7)	18
6.2.6	Ethernet (J16)	18
6.2.7	SATA (J3).....	19
6.2.8	SATA/DOM (J20)	19
6.2.9	SATA DOM Power (J21).....	19
6.2.10	Audio (J8).....	19
6.2.11	LVDS LCD (J11)	20
6.2.12	LCD Backlight (J13).....	20
6.2.13	VGA (J9)	20
6.2.14	HDMI (J10).....	21
6.2.15	Digital I/O (J15)	21
6.2.16	Utility (J5).....	21
6.2.17	mSATA / PCIe MiniCard Socket (J23, J24)	22
6.2.18	PCIe/104 (J1).....	23
6.2.19	PCI-104 (J2).....	24
6.3	List of Connectors.....	25
7	I/O CableS	26
8	Jumper Description	27
8.1	SATA DOM Power / PCI VIO (JP1).....	27
8.2	LVDS Backlight and LVDS VDD (JP2).....	28
9	BIOS Key Features.....	30
9.1	Entering the BIOS.....	30
9.2	Restoring Default BIOS Settings	30
9.3	Upgrading BIOS using SHELL Utility.....	30
9.4	Setting the Date and Time.....	30
9.5	Boot Priority	30

9.6	LED	31
9.7	Quiet / Quick Boot / Splash Screen	31
9.8	Serial Port Configuration	31
10	Getting Started	32
10.1	Development Kit	32
10.2	Quick Setup	32
10.3	Boot Device Options	32
10.4	Installing OS and Booting	33
11	Video Features	34
12	Serial Ports and System Console	35
12.1	Configuration	35
12.2	Console redirection	35
13	Digital I/O	36
14	Software driver overview	37
15	Thermal Solutions.....	38
15.1	Heat Spreader Drawing	38
15.2	Mounting Hole Specifications.	38
15.3	Heat Spreader Installation	39
15.4	Heat Spreader Installed on the Board	40
15.5	Heat Spreader with brackets Installed on the Board	41
16	Specifications.....	42

1 IMPORTANT SAFE HANDLING INFORMATION



WARNING!

ESD-Sensitive Electronic Equipment

Observe ESD-safe handling procedures when working with this product.

Always use this product in a properly grounded work area and wear appropriate ESD-preventive clothing and/or accessories.

Always store this product in ESD-protective packaging when not in use.

Safe Handling Precautions

The Venus SBC contains a high number of I/O connectors with connection to sensitive electronic components. This creates many opportunities for accidental damage during handling, installation and connection to other equipment. The list here describes common causes of failure found on boards returned to Diamond Systems for repair. This information is provided as a source of advice to help you prevent damaging your Diamond (or any vendor's) embedded computer boards.

ESD damage – This type of damage is usually almost impossible to detect, because there is no visual sign of failure or damage. The symptom is that the board eventually simply stops working, because some component becomes defective. Usually the failure can be identified and the chip can be replaced.

To prevent ESD damage, always follow proper ESD-prevention practices when handling computer boards.

Damage during handling or storage – On some boards we have noticed physical damage from mishandling. A common observation is that a screwdriver slipped while installing the board, causing a gouge in the PCB surface and cutting signal traces or damaging components.

Another common observation is damaged board corners, indicating the board was dropped. This may or may not cause damage to the circuitry, depending on what is near the corner. Most of our boards are designed with at least 25 mils clearance between the board edge and any component pad, and ground / power planes are at least 20 mils from the edge to avoid possible shorting from this type of damage. However these design rules are not sufficient to prevent damage in all situations.

A third cause of failure is when a metal screwdriver tip slips, or a screw drops onto the board while it is powered on, causing a short between a power pin and a signal pin on a component. This can cause overvoltage / power supply problems described below. To avoid this type of failure, only perform assembly operations when the system is powered off.

Sometimes boards are stored in racks with slots that grip the edge of the board. This is a common practice for board manufacturers. However our boards are generally very dense, and if the board has components very close to the board edge, they can be damaged or even knocked off the board when the board tilts back in the rack. Diamond recommends that all our boards be stored only in individual ESD-safe packaging. If multiple boards are stored together, they should be contained in bins with dividers between boards. Do not pile boards on top of each other or cram too many boards into a small location. This can cause damage to connector pins or fragile components.

Power supply wired backwards – Our power supplies and boards are not designed to withstand a reverse power supply connection. This will destroy each IC that is connected to the power supply (i.e. almost all ICs). In this case the board will most likely will be unrepairable and must be replaced. A chip destroyed by reverse power or by excessive power will often have a visible hole on the top or show some deformation on the top surface due to vaporization inside the package. **Check twice before applying power!**

Board not installed properly in PC/104 stack – A common error is to install a PC/104 board accidentally shifted by 1 row or 1 column. If the board is installed incorrectly, it is possible for power and ground signals on the bus to make contact with the wrong pins on the board, which can damage the board. For example, this can damage components attached to the data bus, because it puts the $\pm 12V$ power supply lines directly on data bus lines.

Overvoltage on analog input – If a voltage applied to an analog input exceeds the design specification of the board, the input multiplexor and/or parts behind it can be damaged. Most of our boards will withstand an erroneous connection of up to $\pm 35V$ on the analog inputs, even when the board is powered off, but not all boards, and not in all conditions.

Overvoltage on analog output – If an analog output is accidentally connected to another output signal or a power supply voltage, the output can be damaged. On most of our boards, a short circuit to ground on an analog output will not cause trouble.

Overvoltage on digital I/O line – If a digital I/O signal is connected to a voltage above the maximum specified voltage, the digital circuitry can be damaged. On most of our boards the acceptable range of voltages connected to digital I/O signals is 0-5V, and they can withstand about 0.5V beyond that (-0.5 to 5.5V) before being damaged. However logic signals at 12V and even 24V are common, and if one of these is connected to a 5V logic chip, the chip will be damaged, and the damage could even extend past that chip to others in the circuit.

Bent connector pins – This type of problem is often only a cosmetic issue and is easily fixed by bending the pins back to their proper shape one at a time with needle-nose pliers. The most common cause of bent connector pins is when a PC/104 board is pulled off the stack by rocking it back and forth left to right, from one end of the connector to the other. As the board is rocked back and forth it pulls out suddenly, and the pins at the end get bent significantly. The same situation can occur when pulling a ribbon cable off of a pin header. If the pins are bent too severely, bending them back can cause them to weaken unacceptably or even break, and the connector must be replaced.

2 INTRODUCTION

Venus is a 3.5" standard SBC based on 6th generation Intel Skylake processor i7-6600U. The U-series processors are offered in a 1-chip platform that includes the 6th generation Intel Platform Controller Hub (PCH) die on the same package as the processor die. Board provides expansion option over One bank PCIe/104 and PCI-104 connector. It features DDR4 memory on board, top side conduction cooling, two PCIe Minicard sockets, two Gigabit Ethernets and -40 to +85C operation. The board will be of standard 3.5" embedded form factor.

2.1 Standard Configurations

Model number	Processor / speed	Cores	Memory
VNS766-4GD	I7-6600U / 2.6 GHz	2	4GB
VNS563-4GD	I5-6300U / 2.4 GHz	2	4GB

2.2 Features

- ◆ Processor Intel "Skylake" 6th generation Core, two options:
i7-6600U (2.6GHz, Turbo up to 3.4GHz, 4MB Cache, 15W TDP)
i5-6300U (2.4GHz, Turbo up to 3.0GHz, 3MB Cache, 15W TDP)
- ◆ Memory On board 4GB DDR4
Expandable over rugged SODIMM, Up to 16GB
- ◆ Ethernet 1 10/100/1000 Mbps direct from processor
1 10/100/1000 Mbps using one PCIe x1 lane
- ◆ SATA 1 port, direct from processor to standard SATA connector
1 port, direct from processor to SATA DOM
1 port, direct from processor to mSATA
- ◆ USB 2 USB 2.0 ports to standard header
4 USB 2.0 and USB3.0 ports to USB3.0 connector (either/or may be used)
2 USB 2.0 ports on Mini PCIe connector
2 USB 2.0 ports to One Bank PCIe/104
- ◆ VGA Up to 1920 x 1200, using DP to VGA bridge
- ◆ LCD Dual channel LVDS, using eDP to LVDS Bridge
- ◆ HDMI Direct from processor
- ◆ Audio HD Audio with Line In, Mic In, Line Out
- ◆ Serial ports 4 ports with RS-232/422/485 capability
- ◆ Digital I/O 16 lines, configurable 3.3V / 5V logic level
- ◆ Expansion 2 PCIe Minicard with PCIe x1 and USB, 1 shared with mSATA
PCI-104, supports up to 4 I/O boards
One Bank PCIe/104, supports up to 4 PCIe x1 boards

2.3 Operating System Support

- ◆ Windows 10, 8, 7, Linux
- ◆ Driver packages and/or BSPs available for each OS

2.4 Mechanical, Electrical, Environmental

- ◆ Form factor 3.5" Standard form factor (146 x 102mm / 5.75" x 4.00")
- ◆ Cooling Conduction cooling, bottom side heat spreader
- ◆ Power input +9V to +18VDC in; +12V Typical
- ◆ Operating Temp -40°C to +85°C at outer surface of heat spreader
- ◆ Shock Designed to meet MIL-STD-202G, Method 213-B, Table 213-1 Condition A, 50G / 11ms half sine, non-operational
- ◆ Vibration: Designed to meet MIL-STD-202G, Method 214A, Table 214-1, Condition D, 11.95G random vibration, 15 minutes per axis, operational

3 FUNCTIONAL BLOCK DIAGRAM

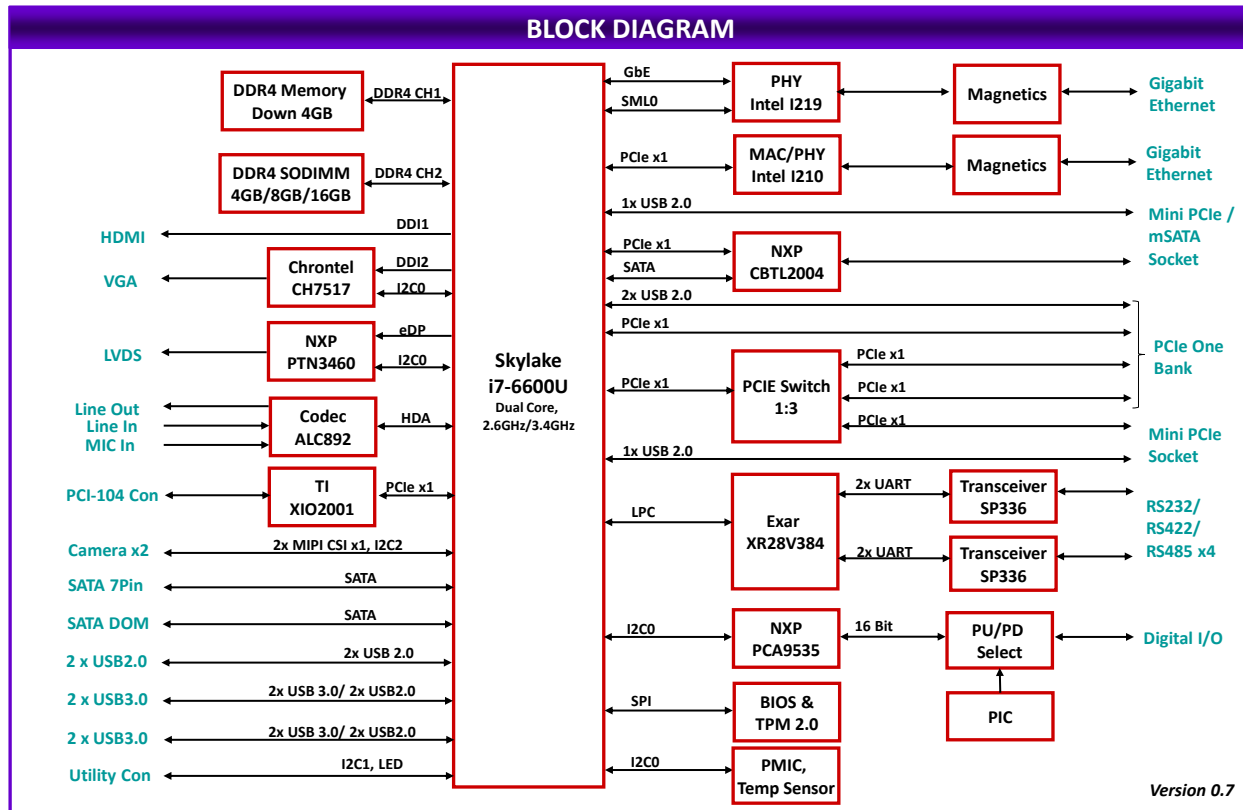

Figure 1 Functional Block Diagram

3.1 Feature Descriptions

This section describes the key subsystems of the Venus SBC.

3.1.1 Processor and Chipset

Venus is based on 6th generation Intel Skylake processor i7-6600U. The U-series processors are offered in a 1-chip platform that includes the 6th generation Intel Platform Controller Hub (PCH) die on the same package as the processor die. It is a dual core, 64 bit processor with a maximum turbo frequency of 3.4GHz.

Venus also supports 6th generation Intel Skylake processor i5-6300U on same package with a maximum turbo frequency of 3.0GHz.

3.1.2 Memory

The design employs DDR4 mixed memory configuration: 4GB Soldered down memory on memory channel 1 and up to 16GB SODIMM on memory channel 2.

Memory can be increased to a total of up to 20GB by adding a DDR4 SODIMM module of up to 16GB on the connector provided. Venus requires DDR4-2133 configuration. For rugged application Venus also supports RSODIMM™ rugged SODIMM modules which can be fixed to the board with two screws for enhanced shock and vibration resistance. Please contact DSC for more details.

3.1.3 Ethernet

The board provides two Gigabit Ethernet ports. One port is derived directly from the 10/100/1000 Mbps MAC within the processor utilizing an external Intel I219 PHY. The second port is derived from an Intel I210IT controller connected via a x1 PCIe lane directly to the processor. The board also includes the necessary magnetics for both ports. For increased ruggedness, Ethernet connection is via a latching pin header, not an RJ-45 jack. The two magnetics components are placed back to back on the PCB to conserve PCB space.

On-board LEDs are provided for Link, Activity, and Speed. The LEDs are located along the board edge near the Ethernet connector. The GbE ports use dual row, 1.25mm pitch latching connectors. The connector does not provide access to the LED signals.

3.1.4 SATA

The board offers three SATA ports, all derived from the processor. Two ports are connected to an industry-standard vertical SATA connector that accepts cables with latching connectors. One of these connectors is placed on the board in a position that allows a miniature SATA disk-on-module to be installed in it and attached with a mounting spacer and screw. The third port is dedicated to the combination mSATA / PCIe MiniCard socket.

3.1.5 USB

The board provides ten USB 2.0 ports and four USB 3.0 ports directly from the processor. Two USB 2.0 ports are connected to the PCIe Minicard socket, two are made available on two USB2.0 latching connectors, four are available on the USB 3.0 connector, and another two are available on one bank PCIe/104 connector.

The USB 3.0 port uses an Intel standard pin header. The USB 2.0 ports use miniature 1.25mm pitch latching connectors. Each connector provides access to two USB ports.

Although the USB 3.0 connector contains both USB 3.0 and USB 2.0 ports, only one or the other can be used for each port position. This is similar to the typical USB 3.0 type A jack which provides access to both 2.0 and 3.0 signals, but only one can be used at a time.

3.1.6 Video

The board offers three video output options: HDMI, VGA and LVDS LCD.

The HDMI port is directly from the processor and is made available on a dual row 1.25mm pitch latching connector.

VGA is realized from the processor's DisplayPort (DP) port using a DP to VGA bridge chip and is available on a 1.25mm pitch latching connector.

Dual channel LVDS interface is obtained using an eDP to LVDS converter (NXP PTN3460) to provide a dual-channel LVDS LCD output.

The LCD backlight control is provided by a PWM circuit. LCD backlight power and control are on a separate latching connector.

3.1.7 Audio

The design provides HD audio support from an ALC892 audio chip. Audio I/O signals include stereo line in, stereo line out and mono mic in. The audio signals are made available on a latching connector.

3.1.8 Serial Ports

The board provides 4 serial ports using the Exar XR28V384 LPC UART. RS-232/422/485 protocols are supported with Exar SP336 multiprotocol transceivers. In RS-232 mode, only signals TX, RX, RTS, and CTS are provided. Protocol selection and TX / RX 120 ohm line termination resistors for RS-422/485 are controlled using GPIO pins from the processor and are configurable via BIOS configuration screens as well as via application software.

Console redirection feature (using a serial port for keyboard input and terminal display via a link to a second computer) is provided in the BIOS on COM1.

3.1.9 Digital IO

The board provides 16 Digital I/O signals with selectable 5V / 3.3V logic levels, selectable pull-up/down resistors, programmable direction, and buffered transceivers. The digital I/O is realized from the I2C interface of the processor using a PCA9535 I2C to GPIO expander. An on-board microcontroller controlled by processor GPIO signals is used to configure the digital I/O logic levels and pull resistors.

3.1.10 Backup Battery

The board contains an on-board RTC battery holder for placing BR-2032/BN coin cell. The default board configuration includes an installed coin cell. A connector is also provided to enable the use of an external battery for rugged applications.

The board is able to boot and function properly without a backup battery installed.

3.1.11 TPM

The board contains Infineon's SLB 9670XQ2.0 TPM module featuring a fully TCG TPM 1.2/2.0 standard compliant module with a SPI interface. TPM can be used as a root of trust for platform integrity, remote attestation and cryptographic services.

3.1.12 PCIe Minicard Socket

The board has two full size (51mm length) PCIe Minicard socket. The top side socket supports both PCIe Minicard and mSATA modules. A PCIe/mSATA switch is used to auto select which interface is active based on the state of CLKREQ# pin driven by an installed module.

3.1.13 PCI-104 and One Bank PCIe/104 Expansion

The board offers I/O expansion via PCI-104 connector and a PCIe/104 OneBank connector.

The PCI-104 bus is realized using by a PCIe to PCI bridge. It supports both 5V and 3.3V logic levels configurable with a jumper. Up to 4 PCI-104 I/O modules can be installed on this connector. If a PC/104-Plus I/O module is used, the ISA bus pins must be cut away, or the ISA connectors removed entirely, to avoid interference with the OneBank connector on the SBC. The configuration of PCI-104 connector without ISA connector is referred to as PCI-104.

The board also supports up to 3 PCIe x1 PCIe/104 modules on the PCIe/104 OneBank connector. This connector is compatible with all versions of PCIe/104, including Type 1, Type 2, and OneBank. Port 4 on the connector is left unconnected due to the limited supply of PCIe x1 lanes. PCIe lane 1 on the connector is direct from the processor, while lanes 2 and 3 come from a PCIe expansion switch.

3.1.14 PCIe link routing

Link 1:	OneBank PCIe/104 connector – Lane 1
Link 2:	PCIe Minicard 1
Link 3:	Processor GbE
Link 4:	I210 GbE
Link 5:	PCIe to PCI Bridge for PCI-104 connector
Link 6:	PCIe 1:3 Switch → One bank PCIe/104 connector Lane 2, Lane 3, PCIe Minicard 2

3.1.15 LED Indicators

The board provides the following LED indicators. All LEDs are located near to a board edge or their respective features. All LEDs are labeled in silkscreen with their function.

Power input:	Green LED, illuminated when Input supply is valid
Power on:	Green LED, illuminated when board is powered on
BIOS LED:	Green, connected to a GPIO line on the processor; this LED is off during power-up and is turned on in the BIOS to indicate a successful system BIOS startup.
Ethernet:	Green LEDs (6): Link, activity, and speed for each port
SATA LED	Green LED, for SATA activity
Digital I/O/ User LED:	Blue, driven with reverse logic from 5V, controlled by processor GPIO
PCIe MiniCard socket:	Green LEDs (3 per socket) to support WWAN, WPAN, WLAN signals from the Mini PCIe connector

3.1.16 BIOS Features

The Venus BIOS provides the following user configurable and controllable features:

- ◆ Boot from LAN (PXE) as well as USB and SATA ports
- ◆ Free boot sequence configuration to allow different boot sequences as first, second and third boot devices
- ◆ Support multi display mode. HDMI, VGA and LVDS can be active simultaneously
- ◆ Console (display and keyboard) redirection to a COM port
- ◆ Custom default settings can be saved without a battery
- ◆ Customizable splash screen
- ◆ Quiet boot option
- ◆ Enable/disable for individual COM ports.
- ◆ Protocol selection for each of the COM ports
- ◆ 120 ohm line termination control for serial ports in RS-422/485 protocol
- ◆ IRQ sharing for COM ports
- ◆ Enable/ disable Digital I/O ports A and B
- ◆ Direction control (Input/ Output) for Digital I/O ports A and B
- ◆ Wake on LAN for on-board Ethernet and minicard socket
- ◆ BIOS LED to indicate successful BIOS initialization
- ◆ Supports standard BIOS hotkey. This includes DEL key to enter BIOS menu; F3 key to load BIOS default settings etc.
- ◆ Password protection
- ◆ Field upgradable via a DOS/Shell utility

3.1.18 Power Supply

The board will operate with an input voltage in the range 9VDC to 18VDC. Nominal input voltage is +12VDC. Typical operating power consumption is in the range of 13-14W (1.1-1.2A at 12V).

The supports ACPI for pushbutton on/off control and also supports standby mode. In standby mode, the board may be powered on via the Wake on Lan feature or using a power button.

All required supply voltages for any installed expansion modules and LCDs are provided by the board's power supply. When sizing a power supply to drive Venus, care should be taken to ensure that the supply can provide enough current for all installed options. The figures below are the design limits of the board. When converting the lower voltage current to main 12V input current, an 85% efficiency factor should be used.

12V	5V	3.3V	Feature
1.0A	2.0A	2.0A	PCI-104 and One Bank modules
		3.0A	PCIe Minicard add-on modules
	0.25A		SATA disk module
	1.4A	0.7A	LCD power
1.1A			LCD backlight
		0.05A	Utility connector
	1.0A		USB 2.0 ports
	3.6A		USB 3.0 port

The +5V and +3.3V pins of the PCI-104 connector and PCIe/104 connector are tied together. The +12V pins from PCI-104 connector are routed directly to the power connector such that the board can be powered over a PCI-104 power module. Maximum allowable reflected ripple, measured at the voltage input connector is 120mV p-p.

NOTE: Since the PCI-104 connector 12V pins are tied directly to the main input voltage, if a PCI-104 module that requires 12VDC is installed, the main input voltage must be 12VDC.

4 MECHANICAL BOARD DRAWING

Dimensions are in inches [mm]. Connector dimensions indicate the center of the pad for pin 1 (pin A1 for the PCI-104 connector).

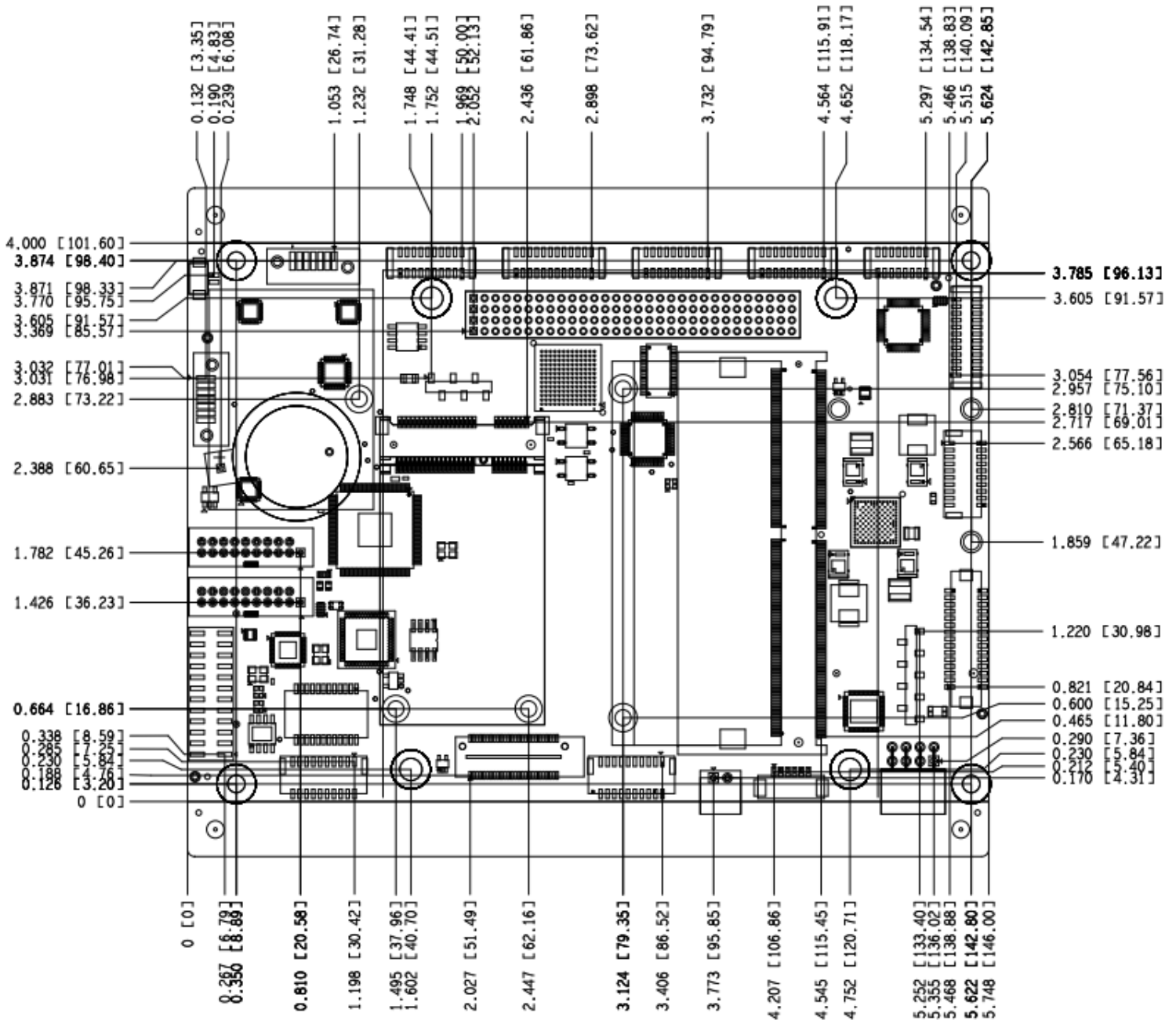
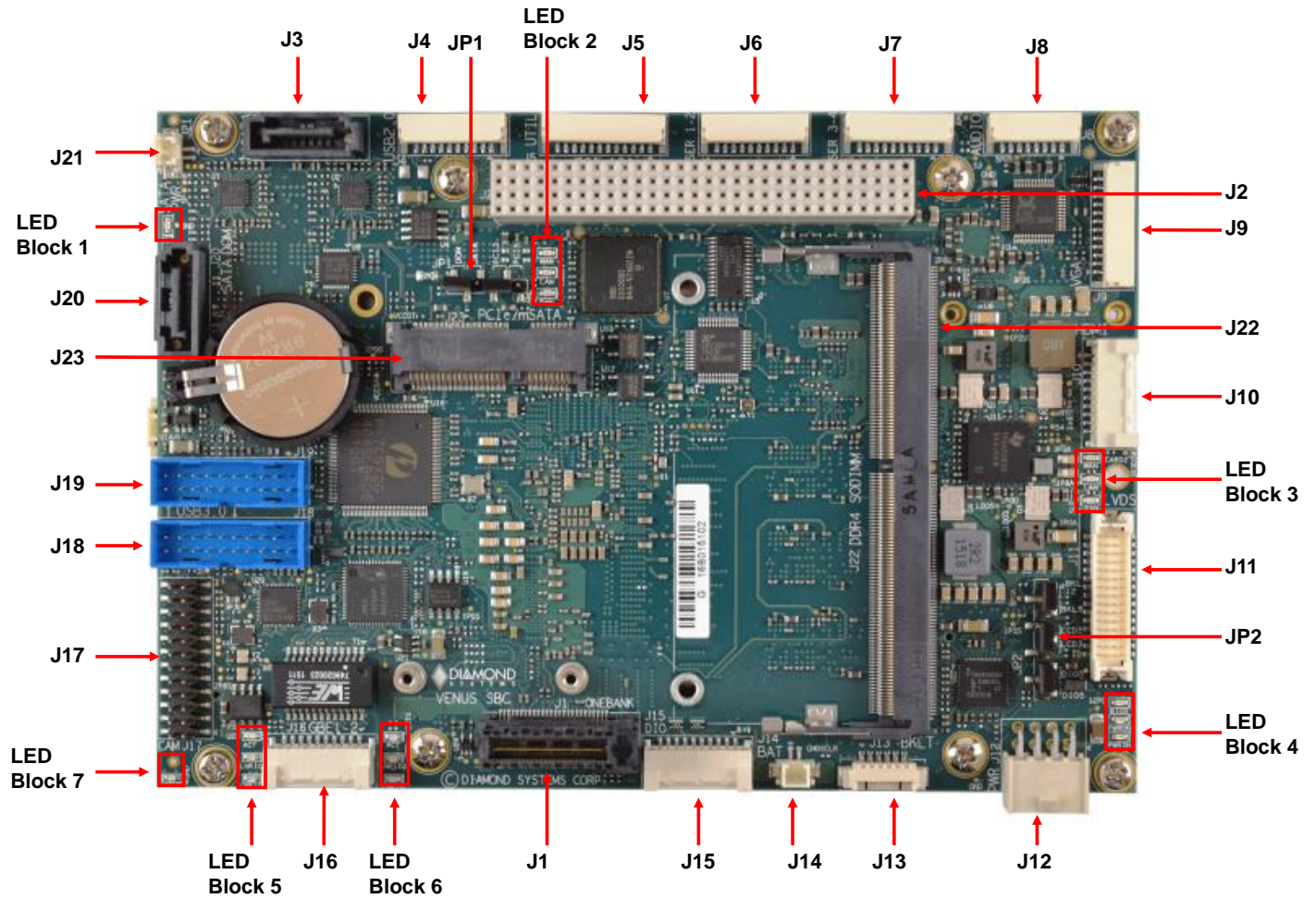

Figure 2: Mechanical Board Drawing

5 BOARD LAYOUT (CONNECTOR AND JUMPER LOCATIONS)



I/O Connectors, Jumpers and LED Summary

Conne tor	Function	Jumper	Function
J1	PC/104 Express	JP1	SATA DOM/Cable selection, PCI I/O Voltage selection
J2	PC/104 – PLUS PCI	JP2	LVDS Vcc & Backlight, Digital IO voltage and pull resistors
J3	SATA port 2		
J4	USB 2.0 Port 5,6	LED Block 1	
J5	Utility Connector	SATA Activity	
J6	Serial ports 1,2	LED Block 2	
J7	Serial ports 3,4	Top LED	mPCIe-1 WAN
J8	Audio	Middle LED	mPCIe-1 LAN
J9	VGA	Bottom LED	mPCIe-1 PAN
J10	HDMI	LED Block 3	
J11	LVDS LCD	Top LED	mPCIe-2 WAN
J12	Power In	Middle LED	mPCIe-2 LAN
J13	LVDS Backlight	Bottom LED	mPCIe-2 PAN
J14	External Battery	LED Block 4	
J15	Digital IO	Top LED	BIOS LED
J16	GbE Port 0,1	Middle LED	Power On LED
J17	MIPI Camera	Bottom LED	Power In LED
J18	USB3.0 Port 1,3	LED Block 5	
J19	USB3.0 Port 2,4	Top LED	GBE0 ACT
J20	SATA port 1	Middle LED	GBE0 Link100
J21	SATA DOM Power	Bottom LED	GBE0 Link1000
J22	DDR4 SODIMM	LED Block 6	
J23	PCIe Mini Card 1	Top LED	GBE1 ACT
J24 (Bottom)	PCIe Mini Card 2	Middle LED	GBE1 Link100
		Bottom LED	GBE1 Link1000
		LED Block 7	
		User LED	

6 I/O CONNECTORS

6.1 Connector Pin-out and Signal Description

6.2 Connector Pin-out and Signal Description

6.2.1 Power In (J12)

Vin is 9-18VDC (12VDC nominal).

Ground	1	2	Vin
Ground	3	4	Vin
Ground	5	6	Vin
Ground	7	8	Vin

Connector used is a custom version of Samtec IPL1.

Mating Cable: DSC 6980512

6.2.2 External Battery (J14)

1	VBAT
2	Ground

VBAT = +3.0V

Connector used is 22-05-7025 right angle type friction lock pin header.

Mating cable: DSC 6980524

6.2.3 USB 2.0 Ports (J4)

The USB2.0 connector provides access to two USB 2.0 ports.

1	USB1 Power
2	USB1 Data-
3	USB1 Data+
4	Ground
5	Shield
6	USB2 Power
7	USB2 Data-
8	USB2 Data+
9	Ground
10	Shield

Connector used is SM10B-GHS-TB Side entry type.

Mating Cable: DSC 6980503

6.2.4 USB 3.0 Port (J18, J19)

There are two USB3.0 headers with identical pinouts. Each USB3.0 header also provides access to two USB 3.0 ports with USB 2.0 backward compatibility. The pinout for the connector is compatible with the Intel standard for USB 3.0 motherboard connectors.

USB1 Pwr	1		USB2 Pwr
USB1 SSRX-	2	19	USB2 SSRX-
USB1 SSRX+	3	18	USB2 SSRX+
Ground	4	17	Ground
USB1 SSTX-	5	16	Ground
USB1 SSTX+	6	15	USB2 SSTX-
Ground	7	14	USB2 SSTX+
USB1 Data-	8	13	Ground
USB1 Data+	9	12	USB2 Data-
ID	10	11	USB2 Data+

Connector used is WUIR-19A1N4BU3N Top entry type.

Mating Cable: DSC 6980100

6.2.5 Serial Ports (J6,J7)

There are two serial port connectors with identical pinouts, two ports per connector. All ports are configurable for RS-232, RS-422, or RS-485. The pinout for the first connector is shown here.

Pin	RS-232	RS-422	RS-485
1	TX1	TX1+	TX/RX 1+
2	RX1	RX1+	NC
3	RTS1	TX1-	TX/RX 1-
4	CTS1	RX1-	NC
5	Ground	Ground	Ground
6	TX2	TX2+	TX/RX 2+
7	RX2	RX2+	NC
8	RTS2	TX2-	TX/RX 2-
9	CTS2	RX2-	NC
10	Ground	Ground	Ground

Connector used is SM10B-GHS-TB Side entry type. Pinout is derived from DS-MPE-SER4M.

Mating Cable: DSC 6980500

6.2.6 Ethernet (J16)

Port 1 DA+	1	2	Port 2 DA+
Port 1 DA-	3	4	Port 2 DA-
Port 1 DB+	5	6	Port 2 DB+
Port 1 DB-	7	8	Port 2 DB-
Port 1 DC+	9	10	Port 2 DC+
Port 1 DC-	11	12	Port 2 DC-
Port 1 DD+	13	14	Port 2 DD+
Port 1 DD-	15	16	Port 2 DD-
Port 1 Shield	17	18	Port 2 Shield
N/C	19	20	N/C

Connector used is SM20B-GHDS-GAN-TF Side entry type. Pinout is derived from Aries.

Mating Cable: DSC 6980513

6.2.7 SATA (J3)

A standard 7 Pin SATA connector is used for external SATA storage devices.

1	Ground
2	SATA 1 TX+
3	SATA 1 TX-
4	Ground
5	SATA 1 RX-
6	SATA 1 RX+
7	Ground

6.2.8 SATA/DOM (J20)

A second standard 7 pin SATA connector is provided for either an external SATA device or a board-mounted SATA-DOM storage device. Pin 7 is connected to a jumper that selects either Ground or 5VDC system voltage rail. Ground is used for an external storage device, and 5V is used for a board-mounted SATA flash disk module. The 5V is connected via a resettable fuse.

1	Ground
2	SATA 1 TX+
3	SATA 1 TX-
4	Ground
5	SATA 1 RX-
6	SATA 1 RX+
7	Ground/5V

6.2.9 SATA DOM Power (J21)

If a SATA DOM module without pin 7 power is used, then it will have a separate power connector to supply 5VDC. Connector J21 may be used for this purpose. DSC does not offer a cable.

1	+5V
2	Ground

Connector used is DF13C-2P-1.25V, Top entry type friction lock pin header.

6.2.10 Audio (J8)

1	LineOut – L
2	LineOut – R
3	GND_Audio
4	LineIn – L
5	LineIn – R
6	GND_Audio
7	MIC IN
8	GND_Audio

Connector used is SM08B-GHS-TB Side entry type friction lock pin header. Pinout is derived from Aries.

Mating cable: 6980508

6.2.11 LVDS LCD (J11)

VDD 5V/3.3V	1	2	VDD 5V/3.3V
VDD 5V/3.3V	3	4	VDD 5V/3.3V
CLK+ Odd	5	6	CLK+ Even
CLK- Odd	7	8	CLK-Even
Ground	9	10	Ground
D0+ Odd	11	12	D0+ Even
D0- Odd	13	14	D0- Even
D1+ Odd	15	16	D1+ Even
D1- Odd	17	18	D1- Even
D2+ Odd	19	20	D2+ Even
D2- Odd	21	22	D2- Even
D3+ Odd	23	24	D3+ Even
D3- Odd	25	26	D3- Even
Ground	27	28	Ground
DDC CLK	29	30	DDC DATA

Connector used is DF-13A-30DP-1.25V Top entry type pin header. Pinout is derived from Helix.

Mating cable: DSC 6981213 is compatible with this connector. The LCD end may need to be replaced depending on the type of LCD used. Because of the wide variety of LCDs and the fact that many applications do not require a display, this cable is not included in the Venus standard cable kit CK-VNS-01.

6.2.12 LCD Backlight (J13)

1	Power, +5V/+12V, jumper selectable
2	Power, +5V/+12V, jumper selectable
3	Ground
4	Ground
5	Backlight Enable (GPIO output), 0 = off, open circuit = on
6	Brightness control

Connector used is JS-1147H-06 Right angle type friction lock pin header.

Mating cable: DSC 6981210 is compatible with this connector. The LCD end may need to be replaced depending on the type of LCD used. Because of the wide variety of LCDs and the fact that many applications do not require a display, this cable is not included in the Venus standard cable kit CK-VNS-01.

6.2.13 VGA (J9)

Pin	Signal	DD15 pin equivalent
1	Red	1
2	Gnd-Red	6
3	Green	2
4	Gnd-Green	7
5	Blue	3
6	Gnd-Blue	8
7	HSync	13
8	VSynC	14
9	Gnd-Sync	10
10	DDC-Data	12
11	DDC-Clock	15
12	Ground	5

Connector used is SM12B-GHS-TB. Side entry type friction lock pin header. Pinout is derived from Aries.

Mating cable: DSC 6980507

6.2.14 HDMI (J10)

Data 2+	1	2	Ground
Data 2-	3	4	Data 1+
Ground	5	6	Data 1-
Data 0+	7	8	Ground
Data 0-	9	10	Clock+
Ground	11	12	Clock-
CEC (NC)	13	14	Reserved
DDC Clock	15	16	DDC Data
Ground	17	18	+5V
Hot Plug Detect	19	20	Chassis ground

Connector used is SM20B-GHDS-GAN-TF. Side entry type friction lock pin header.

6.2.15 Digital I/O (J15)

VIO (fused)	1	2	DIO A0
DIO A1	3	4	DIO A2
DIO A3	5	6	DIO A4
DIO A5	7	8	DIO A6
DIO A7	9	10	DIO B0
DIO B1	11	12	DIO B2
DIO B3	13	14	DIO B4
DIO B5	15	16	DIO B6
DIO B7	17	18	NC
Ground	19	20	Ground

Connector used is SM20B-GHDS-GAN-TF. Side entry type friction lock pin header. Pinout is derived from Aries.

Mating cable: DSC 6980501

6.2.16 Utility (J5)

1	I2C Clock
2	I2C Data
3	Ground
4	Reset-
5	Power Switch-
6	Eth 1 Act
7	Eth 1 Link 100
8	Eth 1 Link 1000
9	Eth 2 Act
10	Eth 2 Link 100
11	Eth 2 Link 1000
12	3.3V (fused)

The 3.3V pin on this connector is connected to the system 3.3V rail through a polyswitch resettable fuse. The fuse is rated for ~100mA maximum sustained current. If DC current exceeds this value, the polyswitch will heat up and create a high resistance to limit current flow. The current is reduced to the level required to maintain the resistance, maintaining a steady state protection condition. When the overload is removed, the polyswitch will cool down and return to normal low-impedance mode.

Connector used is SM12B-GHS-TB. Side entry type friction lock pin header.

Mating cable: DSC 6980514

6.2.17 mSATA / PCIe MiniCard Socket (J23, J24)

Two mini card sockets are used. One is used for PCIe mini card interface and other socket can be used for both PCIe MiniCard and mSATA disk module. The configuration is selected with a switch that is controlled by pin 7. A PCIe Minicard will tie pin 7 to ground, while an mSATA module will leave pin 7 open. Pin 7 has a pull-up resistor on the board. All TX/RX signals are with respect to the host. TX on the socket drives RX on the installed module, and RX on the socket is driven by TX on the installed module.

The two mounting standoffs at the far end of the module installation site are not connected to ground.

PCIe MiniCard	mSATA	mSATA / PCIe MiniCard		
		1	2	+3.3V
		3	4	Gnd
		5	6	+1.5V
Clkreq-		7	8	
Gnd	Gnd	9	10	
PCIe 1 Clk-	PCIe 1 Clk- *	11	12	
PCIe 1 Clk+	PCIe 1 Clk+ *	13	14	
Gnd	Gnd	15	16	
KEY				
		17	18	Gnd
		19	20	Disable-
Gnd	Gnd	21	22	PCIe Reset-
PCIe 1 RX-	SATA 0 RX+	23	24	+3.3V
PCIe 1 RX+	SATA 0 RX-	25	26	Gnd
Gnd	Gnd	27	28	+1.5V
Gnd	Gnd	29	30	SMB Clk
PCIe 1 TX-	SATA 0 TX-	31	32	SMB Data
PCIe 1 TX+	SATA 0 TX+	33	34	Gnd
Gnd	Gnd	35	36	
Gnd	Gnd	37	38	
+3.3V	+3.3V	39	40	Gnd
+3.3V	+3.3V	41	42	WWAN LED-
Ground	Ground	43	44	WLAN LED-
		45	46	WPAN LED-
		47	48	+1.5V
Pull-up to +3.3V	Pull-up to +3.3V	49	50	Gnd
		51	52	+3.3V

* For mSATA mode, the PCIe clock signal is not active because CLKREQ- pin is not driven low by the module.

6.2.18 PCIe/104 (J1)

This connector is implemented to facilitate I/O expansion modules to be plugged onto Venus SBC. Note that, 3 nos of x1 PCIe lanes are connected to the One bank PCIe/104 connector.

USB-OC#	1	+ 5 V T A B	2	PCIe Reset#
+3.3V	3		4	+3.3V
USB_1+	5		6	USB_0+
USB_1-	7		8	USB_0-
Ground	9		10	Ground
PCIe1 Tx+	11		12	PCIe0 Tx+
PCIe1 Tx-	13		14	PCIe0 Tx-
Ground	15		16	Ground
PCIe2 Tx+	17		18	
PCIe2 Tx-	19		20	
Ground	21		22	Ground
PCIe1 Rx+	23		24	PCIe0 Rx+
PCIe1 Rx-	25		26	PCIe0 Rx-
Ground	27		28	Ground
PCIe2 Rx+	29		30	
PCIe2 Rx-	31		32	
Ground	33		34	Ground
PCIe1 Clk+	35		36	PCIe0 Clk+
PCIe1 Clk-	37		38	PCIe0 Clk-
+5VSB	39		40	+5VSB
PCIe2 Clk+	41		42	
PCIe2 Clk-	43		44	
Ground	45		46	Ground
SMB Data	47		48	
SMB Clk	49		50	
SMB Alert#	51		52	

6.2.19 PCI-104 (J2)

The board contains a non-stack through / short pin PCI-104 connector on the top side in the standard position as described by the PC/104-Plus specification.

J2				
Pin	A	B	C	D
1	GND/5.0V KEY ²	Reserved	+5	AD00
2	VI/O	AD02	AD01	+5V
3	AD05	GND	AD04	AD03
4	C/BE0*	AD07	GND	AD06
5	GND	AD09	AD08	GND
6	AD11	VI/O	AD10	M66EN
7	AD14	AD13	GND	AD12
8	+3.3V	C/BE1*	AD15	+3.3V
9	SERR*	GND	SB0*	PAR
10	GND	PERR*	+3.3V	SDONE
11	STOP*	+3.3V	LOCK*	GND
12	+3.3V	TRDY*	GND	DEVSEL*
13	FRAME*	GND	IRDY*	+3.3V
14	GND	AD16	+3.3V	C/BE2*
15	AD18	+3.3V	AD17	GND
16	AD21	AD20	GND	AD19
17	+3.3V	AD23	AD22	+3.3V
18	IDSEL0	GND	IDSEL1	IDSEL2
19	AD24	C/BE3*	VI/O	IDSEL3
20	GND	AD26	AD25	GND
21	AD29	+5V	AD28	AD27
22	+5V	AD30	GND	AD31
23	REQ0*	GND	REQ1*	VI/O
24	GND	REQ2*	+5V	GNT0*
25	GNT1*	VI/O	GNT2*	GND
26	+5V	CLK0	GND	CLK1
27	CLK2	+5V	CLK3	GND
28	GND	INTD*	+5V	RST*
29	+12V	INTA*	INTB*	INTC*
30	-12V	Reserved	Reserved	GND/3.3V KEY ²

6.3 List of Connectors

The following table provides a summary of all I/O connectors on the board.

Function	Manufacturer	Part no.	Description	Mating part	Mating Cable
Power in	Samtec	ASP-194529-01	2x4 box header T/H Right angle .1" pitch	IPD1-04-D-K	6980512
External battery	Molex	22-05-7025	2 pos. 2.54mm pitch Vertical latching	0050375023	6980524
USB 2.0	JST	SM10B-GHS-TB	10 pos. 1.25mm pitch Right angle latching	GHR-10V-S	6980503
USB 3.0 / 2.0	Winning	WUIR-19A1N4BU3N	USB 3.0 Motherboard connector	Generic	6980100
Serial ports	JST	SM10B-GHS-TB	10 pos. 1.25mm pitch Right angle latching	GHR-10V-S	6980500
Ethernet	JST	SM20B-GHDS-GAN-TF	20 pos. 1.25mm pitch Right angle latching	GHDR-20V-S	6980513
SATA	Generic	Generic	7-pin SATA connector, vertical	Generic	6989101
SATA DOM Power	Hirose	DF13C-2P-1.25V	2 pos. 1.25mm pitch vertical latching	DF13-2S-1.25C	6980511
Audio	JST	SM08B-GHS-TB	8 pos. 1.25mm pitch Right angle latching	GHR-08V-S	6980508
LCD	Hirose	DF13A-30DP-1.25V	40 pos. .050" pitch dual row vertical latching	DF13-30DS-1.25C	6981213
LCD backlight	Chyao Shiunn	JS-1147H-06	6 pos. 1.25mm pitch Right angle	JS-1146-06	6981214
VGA	JST	SM12B-GHS-TB	12 pos. 1.25mm pitch Right angle latching	GHR-12V-S	6980507
HDMI	JST	SM20B-GHDS-GAN-TF	20 pos. 1.25mm pitch Right angle latching	GHDR-20V-S	6980519
Digital I/O	JST	SM20B-GHDS-GAN-TF	20 pos. 1.25mm pitch Right angle latching	GHDR-20V-S	6980517
Utility	JST	SM12B-GHS-TB	12 pos. 1.25mm pitch Right angle latching	GHR-12V-S	6980514
PCIe Minicard	JAE	MM60-52B1-E1-R650 + NT4R1600 spacer	52-pin Minicard, full size, with PCB mount threaded spacers	-	-
SODIMM	Foxconn	AS0A826-H2SB-7H	260PIN DDR4 SODIMM Connector	-	-
PCI-104	EPT	264-61303-02	30 x 4 pin 2mm pitch with solder tails	-	-
PCIe One Bank	Samtec	ASP-142781-07	52 Pos Top Mount	-	-

7 I/O CABLES

Photo No:	Cable Part No	Description	Venus Connector
1	6980514	Utility	J5
2	6980517	Digital I/O	J15
3	6980507	VGA	J9
4	6980508	Audio	J8
5	6989101	SATA	J20, J3
6	6980513	Ethernet	J16
7	6980500	Serial ports	J6, J7
8	6980100	USB 3.0	J18, J19
9	6980503	USB 2.0	J4
10	6980524	Battery	J14
11	6980512	Power in	J12
12	6980519	HDMI	J10

Note: HDMI cable only available in CK-VNS-02 cable kit.

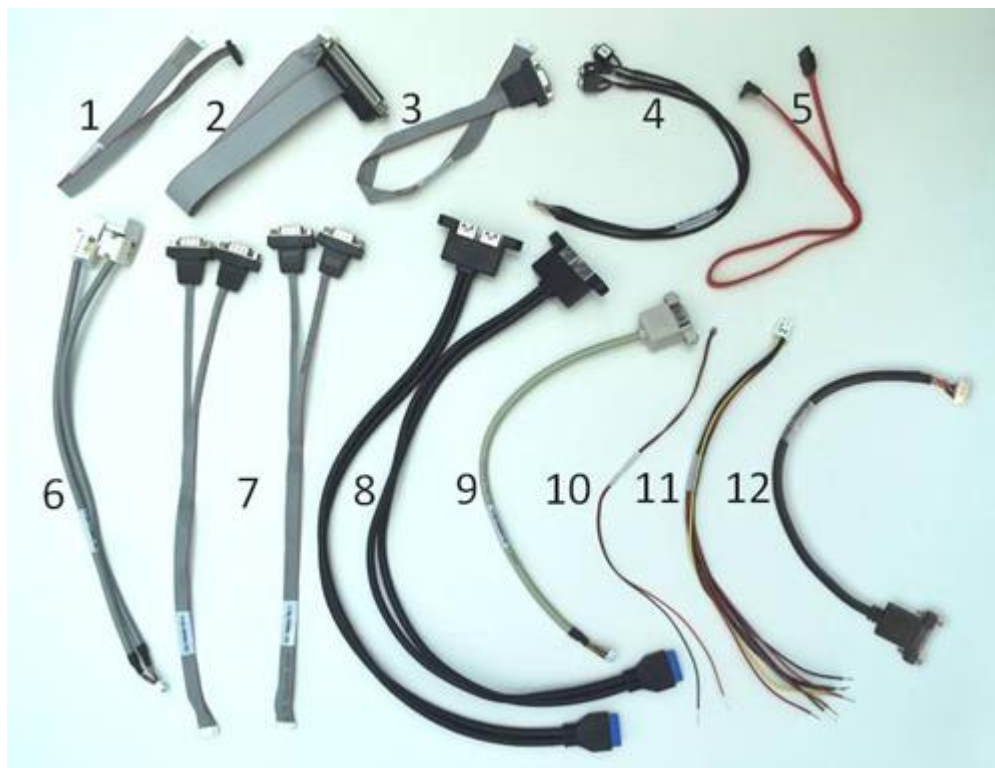

Figure 2 I/O Cables

8 JUMPER DESCRIPTION

Following drawing shows only the connectors and jumper blocks on the board. The default jumper positions are shown in blue.

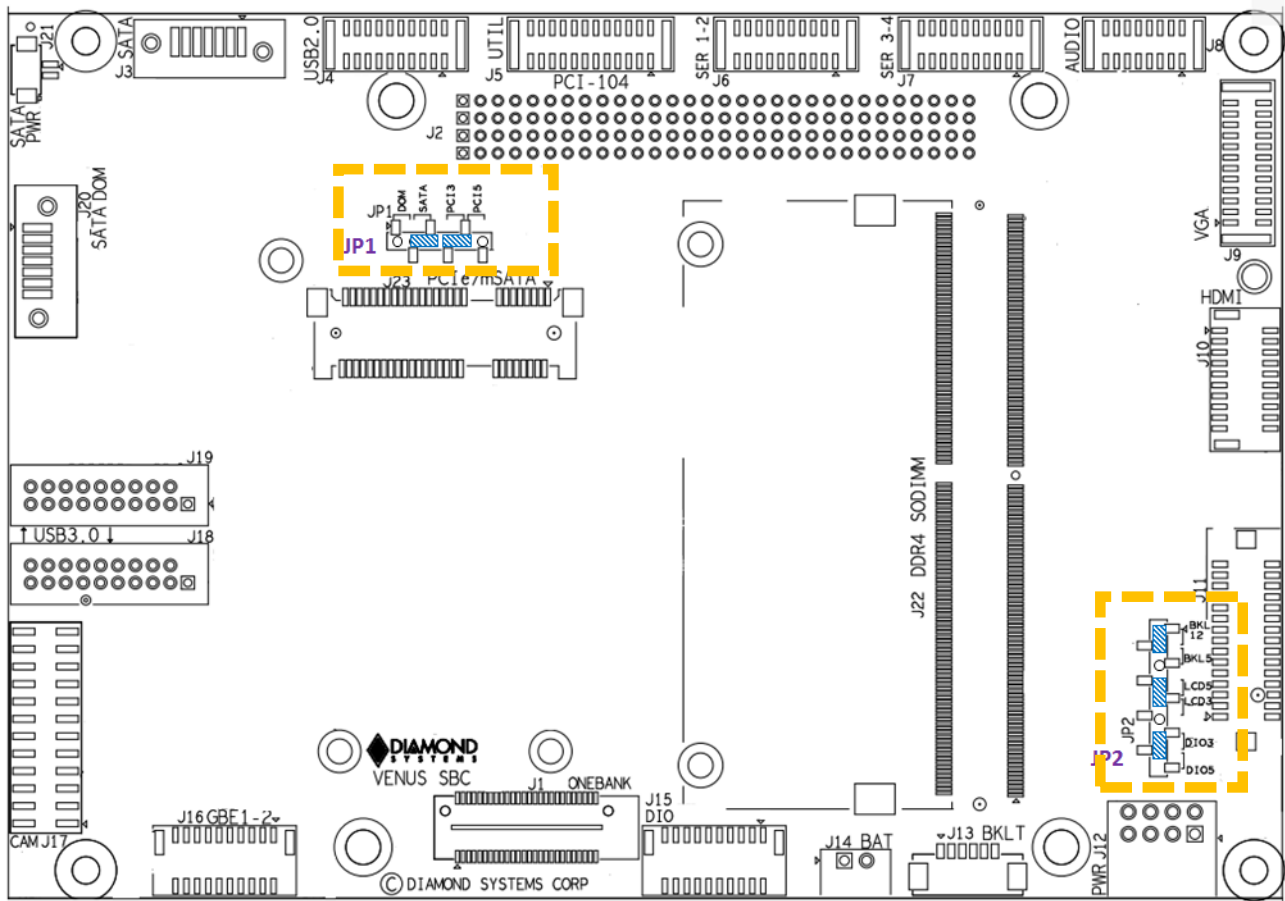

Figure 3 Default Jumper locations

<i>Jumper</i>	<i>Description</i>
JP1	SATA DOM Power, PCI VIO
JP2	LVDS LCD VCC and Backlight

8.1 SATA DOM Power / PCI VIO (JP1)

The 7th pin of the SATA connector J20 can be configured for SATA DOM or for SATA cable. By default, 7th pin of J20 is connected to ground for the SATA cable.

The IO voltage of PCI data/address lines can be configured for 3.3V or 5V.

The default jumper location is shown in Figure 4

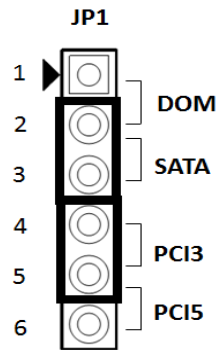

Figure 4 Jumper Block JP1

The following table shows the different combinations of jumper block JP1. The row in bold and italics shows the default configuration of jumper block JP1.

1-2	2-3	4-5	5-6
In	Out	In	Out
In	Out	Out	In
<i>Out</i>	<i>In</i>	<i>In</i>	<i>Out</i>
Out	In	Out	In

Note:

1. Jumpers should be installed in either positions 4-5 or 5-6.

8.2 LVDS Backlight and LVDS VDD (JP2)

Jumper block JP2 configures the voltage supply for the LCD backlight, LVDS VDD and DIO Voltage as well. The orientation of the block in the diagrams matches the orientation of the jumper block when the board is rotated so that the Power in connector is on the lower edge.

Available options are +5V and +12V. 5V is generated on board and +12V is needed for the LCD backlight, is powered via the power connector J12.

For DIO, available options are 5V and 3.3V. By default, DIO voltage is provided with 3.3V

By default, LVDS backlight is provided with +12V and the LVDS VDD is provided with 3.3V. Figure 5 shows the default jumper locations.

Note that the +12V is directly supplied from Input power connector. If the Input supply is other than 12V, user should not mount this jumper and supply the LCD backlight externally.

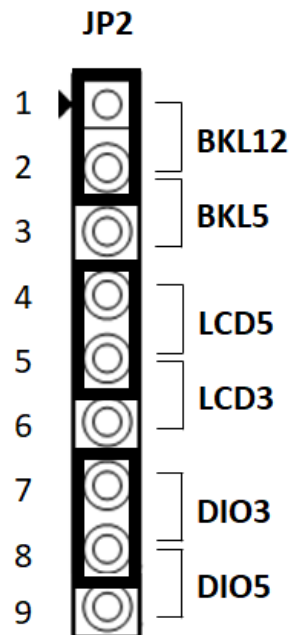

Figure 5 Jumper Block JP2

The following table shows different combinations of jumper locations on JP2.

1-2	2-3	4-5	5-6	LVDS Backlight	LVDS VDD
<i>In</i>	<i>Out</i>	<i>In</i>	<i>Out</i>	12V	5V
In	Out	Out	In	12V	3.3V
Out	In	In	Out	5V	5V
Out	In	Out	In	5V	3.3V

7-8	8-9	DIO Voltage
<i>In</i>	<i>Out</i>	3.3V
Out	In	5V

Note:

1. Voltage supply on LVDS backlight will not depend on or affect the voltage input of LVDS.
2. Do not install a jumper on 3-4,6-7 positions.

9 BIOS KEY FEATURES

The BIOS on Venus provides access to many valuable features. These instructions show how to enter the BIOS and set up features.

9.1 Entering the BIOS

The BIOS may be entered during startup by pressing the **DEL** key on an attached keyboard. Press the key repeatedly soon after a power-on or reset until the BIOS screen appears.

After a specific period during startup (generally a few seconds), the BIOS will ignore the DEL key. If the system does not respond expectedly after pressing the DEL key, user can simply reset the board (or power down) and try again.

9.2 Restoring Default BIOS Settings

While making changes to the BIOS settings, the new settings are stored in SPI flash internal in the DX3 processor. If the user wants to restore the BIOS settings to default state, follow the procedure listed below.

1. Connect a keyboard to the USB keyboard port or PS/2 keyboard port and connect a monitor.
2. Reboot the CPU (reset or power-down and power-up).
3. Hold down the F3 key while the CPU is booting.
4. The board will boot up normally. The BIOS settings will be reset to their defaults.

End key functionality also works in BIOS menu. When the BIOS menu is displayed press the end key.

9.3 Upgrading BIOS using SHELL Utility

Please follow the below steps for BIOS programming through SHELL Utility.

5. In BOOT menu, enter launch shell based file systems to boot to shell. Make sure that Shell based USB flash disk is connected to one of the USB ports.
6. Once booted to shell, identify which is the file system for USB flash disk. It can be fs0 or fs1 or fs2. You can check this by pressing page up button.
7. Make sure that afuefix64.efi utility and BIOS file that need to programmed are available in the root folder.
8. Then follow the below commands.
fs0:
afuefix64.efi <BIOS_filename>.bin /b /p /n
9. While BIOS is getting programmed, the status will be displayed. Wait for 100% completion and switch-off the board.
10. Turn-on the board, confirm the BIOS programming by checking BIOS version in BIOS menu.

9.4 Setting the Date and Time

To set the date and time in the BIOS, select **Main** menu, then enter the date and time at the top of the screen. This screen also displays the CPU speed and memory capacity of the board.

9.5 Boot Priority

To select Boot devices and priority, go to the **Boot** menu and select **Boot Device Priority**. Only devices which are connected to the board will appear in the list of options. Therefore, if the user wants to select a hard drive or USB device as the boot device, CPU should be connected first, then boot up and enter the BIOS, then select it as a boot device. If this menu option does not appear on the screen, it means that the on-board flash drive is not enabled, and either no boot devices are attached or the CPU does not recognize any attached boot devices. User can change the boot devices priority in this screen.

9.6 LED

A green BIOS LED has been provided to indicate that the board has been booted to BIOS GUI. The location of the BIOS LED is being shown in the Board Layout Section.

9.7 Quiet / Quick Boot / Splash Screen

Quiet boot replaces the system status and configuration screen that appears during startup with a blank screen or custom splash screen (if available). Quick boot turns off memory test during startup to save time. To enable these features, go to the Boot menu, then select Boot Settings Configuration. Diamond can provide custom splash screens upon request from an image file.

9.8 Serial Port Configuration

Venus SBC supports 4 serial ports. All the 4 ports support RS-232/422/485 functionalities. The functionality can be configured from the BIOS GUI. In BIOS setup go to advanced menu then Serial/Parallel port configuration. Select the appropriate mode for the Serial Ports

10 GETTING STARTED

This section describes the steps needed to get Venus SBC up and running, and assumes that user also has a Venus Development Kit or Venus Cable Kit. The Cable Kit includes all cables needed for the I/O, except the LCD and backlight. The Development Kit includes the Cable Kit, an AC adapter to power the board, a SATA hard drive, and the hard drive programmer board.

10.1 Development Kit

<i>Model Number</i>	<i>Description</i>
VNS766-4GD	Venus Development Kit with Venus-i7 6600U, 2.6GHz CPU, 4GB DDR4 SBC, cables and Windows 7/8.1/10 OS
VNS563-4GD	Venus Development Kit with Venus-i5 6300U, 2.4GHz CPU, 4GB DDR4 SBC, cables and Windows 7/8.1/10 OS

10.2 Quick Setup

1. Attach VGA cable 6980507 and USB cables 6980503 as needed.
2. Attach display, keyboard, and mouse (if needed) to the cables.
3. Connect the jumpers as mentioned in Section 8 for a default settings or can be changed as desired by the user.
4. Connect power (12V) to power input connector J12 using external power supply with power cable 6980512. The input connector and cable keyed to prevent incorrect connection.

WARNING: Attaching the power connector incorrectly will destroy the Venus SBC!

5. For a quick verification that the system is set up and working properly, if no boot device is attached, the system will boot to BIOS mode.

10.3 Boot Device Options

Venus can boot from SATA or any of the available USB ports or PXE (10/100 Ethernet Port only). Either a board powered SATA DOM or an externally powered SATA HDD can be connected to the SATA port. DSC will provide a flash-disk (SATA DOM or mSATA) with pre-loaded OS.

WARNING: It is possible to destroy the Venus SBC by connecting a SATA cable incorrectly (reverse orientation or offset from correct position). Always use keyed cables to avoid connection errors.

The Boot device selection and priority are configured in the BIOS **Boot** menu. Only devices which are connected to the SBC will appear in the list of options. Therefore if user wants to select a hard drive or USB device as the boot device, the SBC should be connected first, then boot up and enter the BIOS, then select it as a boot device.

The following are a few example boot scenarios.

- ◆ Install an externally powered SATA hard drive directly on the SATA connector (J3).
- ◆ Attach a SATA DOM on the SATA connector (J20) (the Venus SBC will provide power to the SATA DOM over Jumper JP1 1-2)
- ◆ Attach a mSATA device on the Mini PCIe socket (J23)
- ◆ Attach a bootable USB device to one of the USB ports (J4, J18, J19).
- ◆ PXE boot over Ethernet (J16)

10.4 Installing OS and Booting

Ensure that SATA data cable and power cable are connected to SATA HDD. Follow below steps to install Windows 8.1/10 operating system in SATA HDD.

- ◆ Connect a USB pen drive to a USB port of (J4) Venus board having Windows 10 installation image.
- ◆ Boot the Venus board to BIOS. The SATA HDD and USB device should be detected in BIOS under boot devices.
- ◆ Under boot priorities, set highest priority for USB.
- ◆ Save BIOS settings and restart.
- ◆ Windows 10 installer would start running. Follow the instructions in the installer.
- ◆ Upon successful installation, boot to Windows 10 and install the necessary drivers.
- ◆ For installing Windows 7 OS, special instructions need to be followed. Please contact DSC for the same.

11 VIDEO FEATURES

Venus SBC offers three video output options: 2 DDI and one eDP.

The DDI ports are configurable for either HDMI 1.4, DP 1.1a, or eDP. All the three outputs can be active at any time.

DDI port 1 is configured as HDMI 1.4 and supports a maximum resolution of 1920 x 1080 x 60Hz x 24bpp.

DDI port 2 is used for VGA and VGA is realized using DP to VGA converter. Maximum resolution of VGA is 1920 x 1200 x 60Hz x 24bpp.

An eDP to LVDS converter provides a dual-channel LVDS LCD output. Maximum LVDS resolution is 1920 x 1080 x 60Hz x 24bpp. The LCD backlight control is provided by a PWM circuit. LCD backlight power and control are on a separate latching connector.

12 SERIAL PORTS AND SYSTEM CONSOLE

12.1 Configuration

Venus SBC supports total 4 serial ports. All the 4 ports support RS-232/422/485 modes. The modes can be configured in BIOS.

12.2 Console redirection

Connect any of the Venus serial ports to PC. In BIOS menu, go to **Advanced** settings menu, then in Remote Access Configuration enable the Remote access feature. Then select the serial port. User should see the BIOS setup menu in the PC console.

13 DIGITAL I/O

The 16 digital I/O lines are realized using the I2C to GPIO expander and are available on external header (J15). The digital I/O voltage can be configured as either +3.3V or 5V via [JP2](#) jumper settings. The digital I/O lines can be software-configured for pull-up / down resistors.

Each 8bit digital IOs can be configured for PU/PD. Below are the digital IO specification.

No of IO lines	16
Direction	Programmable bit by bit.
Polarity	Programmable bit by bit
Input voltage	VDD= 5V
Logic 0:	0.0V min, 1.5V max, $\pm 1\mu\text{A}$
Logic 1:	3.5V min, 5.5V max, $\pm 1\mu\text{A}$
Output Voltage	VDD= 5V
Logic 0:	0.0V min, 0.7V max, +14mA(Typ)
Logic 1:	4.1V min, 5.0V max, -10mA(Typ)
Input voltage	VDD= 3.3V
Logic 0:	0.0V min, 0.99V max, $\pm 1\mu\text{A}$
Logic 1:	2.31V min, 3.3V max, $\pm 1\mu\text{A}$
Output Voltage	VDD= 3.3V
Logic 0:	0.0V min, 0.7V max, +14mA(Typ)
Logic 1:	2.65V min, 3.3V max, -10mA(Typ)

14 SOFTWARE DRIVER OVERVIEW

Venus SBC supports Windows 7/8.1/10 and Linux operating systems. Software and Hardware Development kits contain a SATA DOM installed with either Windows 10 or Linux. All the necessary I/O drivers are also available as part of the Development Kit. Please contact Diamond Systems for more details.

Some of the drivers that are required with the Windows 10 operating system are given below. These drivers are available for download from Diamond Systems' website.

1. Audio Driver
2. Chipset Driver
3. Gigabit Ethernet Driver
4. Graphics Driver

15 THERMAL SOLUTIONS

Venus SBCs come with a heat spreader which is mounted on the bottom side of the board. The mechanical drawing of the heat spreader and the drawing for the heat spreader installed on the board are shown below.

15.1 Heat Spreader Drawing

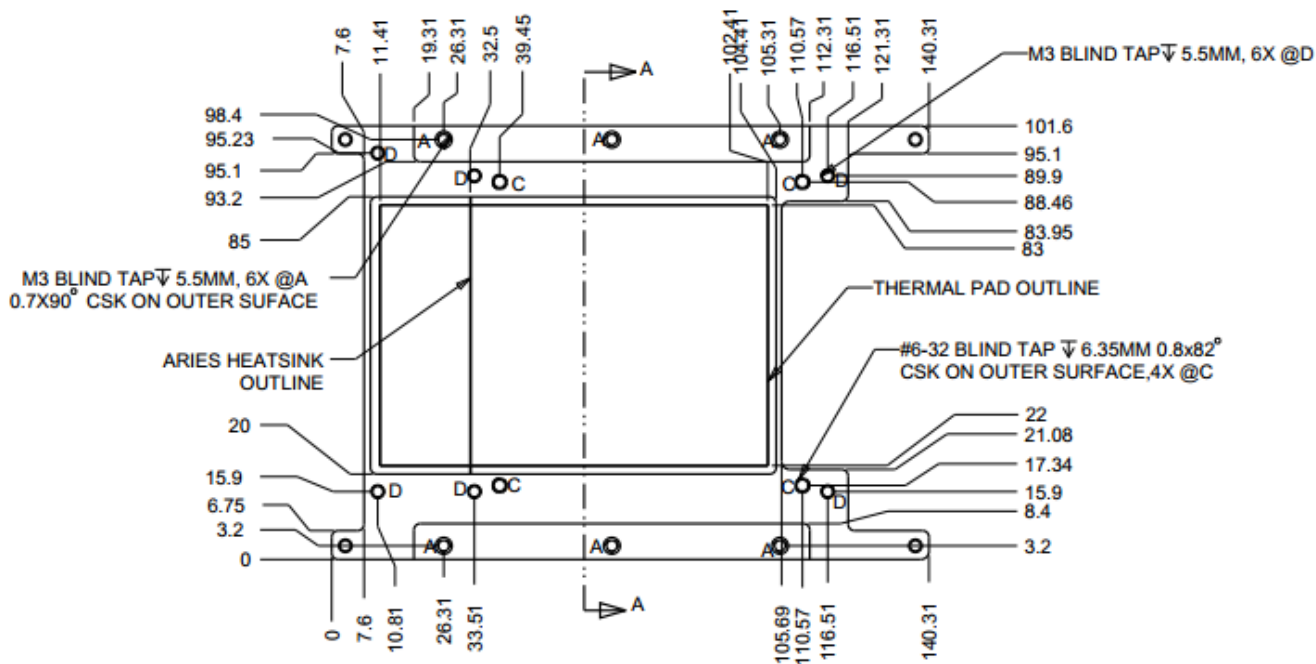

Figure 6 Mechanical Drawing of the Heat Spreader (Bottom View)

15.2 Mounting Hole Specifications.

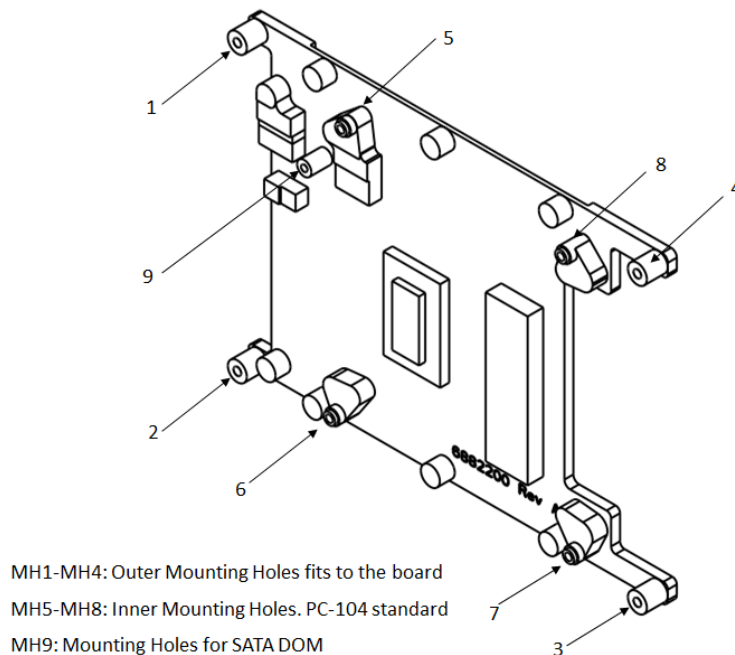

Figure 7 Mounting Hole Specification

15.3 Heat Spreader Installation

Observe ESD safe handling procedures always.

1. Inspect the Heat Spreader and make sure thermal pads are in good condition.
2. Remove all thermal pad liners from bottom of heat spreader. Avoid any contamination of exposed thermal pad surfaces. Refer Figure 8 for reference.

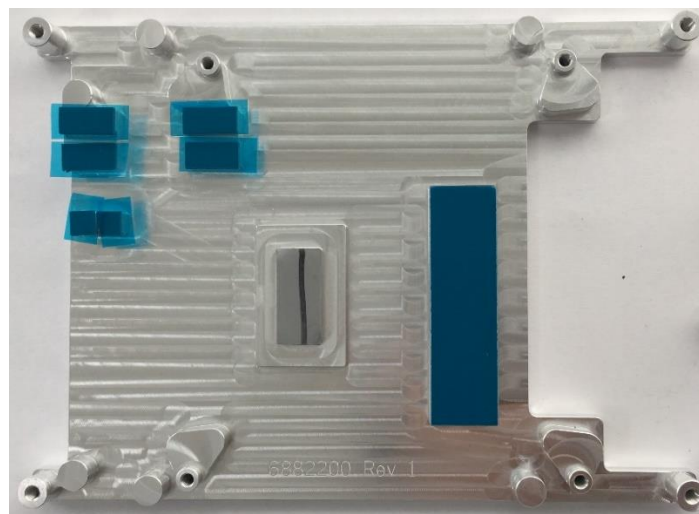

Figure 8 Thermal Pad liners location

15.4 Heat Spreader Installed on the Board

Figure below shows the side view of the heat spreader installed on the Board

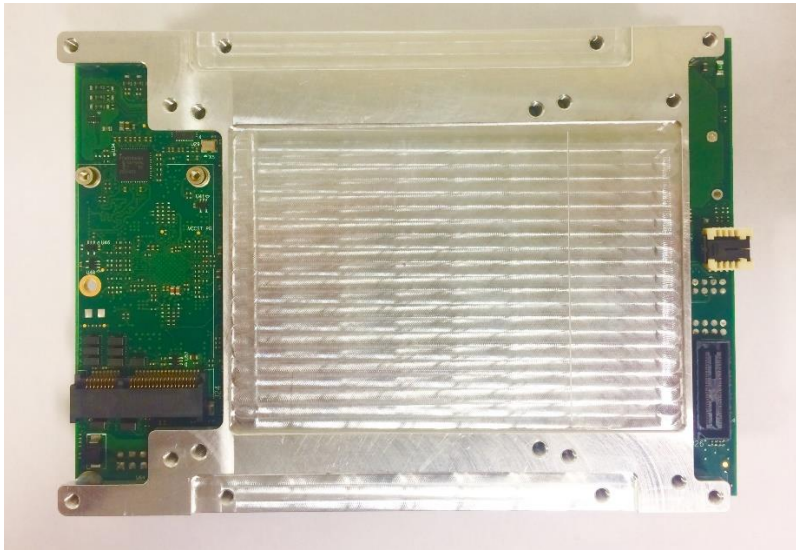

Figure 9 Heat Spreader Installed on the board.

15.5 Heat Spreader with brackets Installed on the Board

Figure below shows the side view of the heat spreader with the bracket installed on the Board

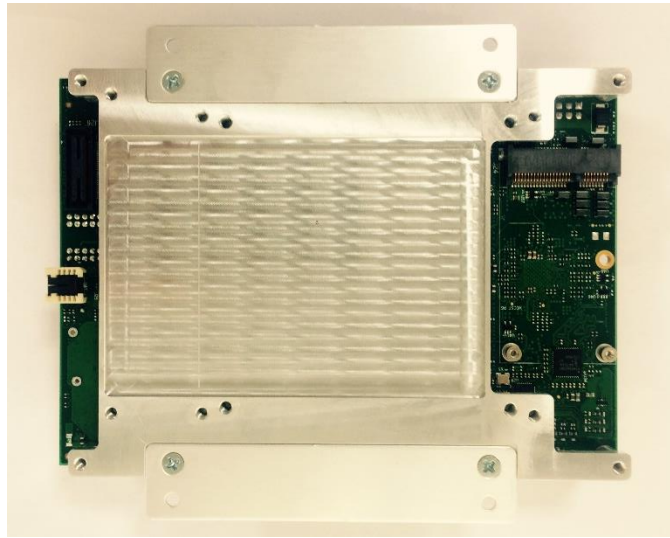

Figure 10 Heat Spreader with Bracket

16 SPECIFICATIONS

<i>Item</i>	<i>VNS766-4GD</i>	<i>VNS563-4GD</i>
Processor	2.6 GHz dual core Skylake i7-6600U	2.4GHz dual core Skylake i5-6300U
Speed	2.6GHz	2.4GHz
Cooling	Heat Spreader	
System bus		
SDRAM memory	Up to 20GB DDR4 4GB onboard + upto 16GB via SODIMM	
Display type	VGA HDMI Dual Channel LVDS LCD	
USB ports	2x USB2.0 4x USB3.0/USB2.0	
Serial ports	4 RS-232/422/485 ports	
Audio	HD Audio ALC892 CODEC with stereo line out, line in and microphone	
Networking	Two 10/100/1000Mbps Ethernet ports	
Mass storage	1 SATA port for external hard drive 1 SATA port for external hard drive or SATA-DOM 1 mSATA	
Expansion bus	PC-104 PCI Bus & One Bank PCIe connector 2 Mini PCIe Full card size	

Mechanical / Environmental

System input voltage	+9VDC +/-5% to + +18VDC +/-5%, Typ:12V
Power consumption	14W Typical @12V input
Dimensions	4.0" x 5.748" (101.6mm x 146mm)
Weight	
Operating temperature	-40°C to +85°C (-40°F to +185°F)
Shock	MIL-STD-202G compatible
Vibration	MIL-STD-202G compatible
RoHS	Compliant